



MTM

THE NEW RANGE OF
MODULAR VIDEO
ENTRY

CAME
safety&comfort

bpt

CONTENTS

GENERAL

MTM is now here: the modular entry panel	2
Why choose a modular entry panel?	4
MTM or MTM VR?	6
Double solution: recess or wall-mounted	8
From 1 to 4 modules	9
Install MTM	10
Versatility: choose the system most suited to you	12
Many functions: the MTM modules	14
Technological heart and many advantages	16
Special functions	20
Version with buttons	22
Digital version	23
MTM VR: vandal-proof version	24
Custom vandal-proof plaques	25
Mounting and installation	26
Came Connect	28
XIP Mobile App	29
MTM: the best-selling setups	30
MTM VR: the best-selling setups	32
Example systems	34
KIT FREE MTM	38
Codes	40

MTM IS NOW HERE: THE ENTRY PANEL THAT GOES BEYOND Z

It's been a challenging project, but after analyzing, planning, researching and developing, we've reach our goal: to create the most **complete modular range** on the market.

No more compromises. With **MTM** you can create all the solutions you want.



WHY GO MODULAR? POINT SURFACE

Choosing **MTM** means choosing a product made specifically for you and your needs.

We've worked hard to make it simple, yet versatile and suitable to all, **from small residential systems to large urban compounds.**

To achieve these results we started from four key elements that have stayed with us for the entire project.

- **Sleek**
- **Versatile**
- **Modular**
- **High-tech**

These elements blend to create a new entry panel, a cutting-edge solution designed to enhance your business, which provides countless functions for you and your customers.

DESIGN

Essential and functional. The satin-aluminum finish makes this entry panel ideal for installing on any surface. The attention to details such as sound diffusion via camera lens speakers, two-color backlighting and much more makes MTM unique.

VERSATILITY

You are requested to install systems everyday. Some may be simple while other can be complex. We want to simplify complexity. That's why we've blended all of our systems into this range. Two wires, multi-wired or IP, from any system you need, we have the solution for you.

MODULAR

Easy to install, custom solutions and endless combinations. That's what MTM is about. Set up your very own entry panel, change it at will, add new functions and open the doors to communication.

TECHNOLOGY

A blending of the best technology and extensive experience really stands out in each module of the range. Each functions is designed in extreme detail to fully meet your needs.

MTM OR MTM VR, WHICH SIDE ARE YOU ON?

MTM

The perfect choice, always. **Anodized and satin-finished aluminum profile and frontpieces** make it uniquely sturdy and sleek. Double backlighting is a plus: choose what you prefer between blue or white.

Protection rating **IP54** and **IK07** make it **shock resistant and water and dust proof.**

Available with a handy **rain hood**, for both the recess-mounting and wall-mounting boxes.





MTM VR

And if that isn't enough, choose **MTM VR, the vandal-resistant version.** Profile and frontpieces made entirely of Zamak, **crush-proof buttons** and **custom screws.**

We are offering you the best in durability while keeping all of the benefits provided in our standard version.

Protection rating **IP54** and **IK09** level shock-resistance.



DOUBLE SOLUTION

RECESS-MOUNTED

Just **13 mm thick**, by installing an **MTM** recess-mounting **plaque** you will only notice it because of its **looks**. A great advantage and its compatibility with our competitors' recess-mounting boxes.*



Width: **130 mm**



Thickness: **13 mm**

Rain hood



Width: **136 mm**



Thickness: **34 mm**

WALL-MOUNTED

When the recess-mounting installation is not doable, you can opt for our wall-mounting box. Its **64 mm thickness** provides high level protection from **shock** and **water damage**, thanks to its **rain hood**.

Rain hood



Width: **135 mm**



Thickness: **64 mm**

*BTicino and Comelit

FROM 1 TO 4 MODULES

1, 2, 3...
and from today 4.

Set up an entry panel with an additional module.
In **40 centimeters** we give you the
chance to set up a **4-module**
entry panel. Add all the functions you
need. Never again give up due to
lack of space.



AND FOR THOSE THAT THINK BIG...

Up to 6 or 9 horizontally and vertically composed
modules.

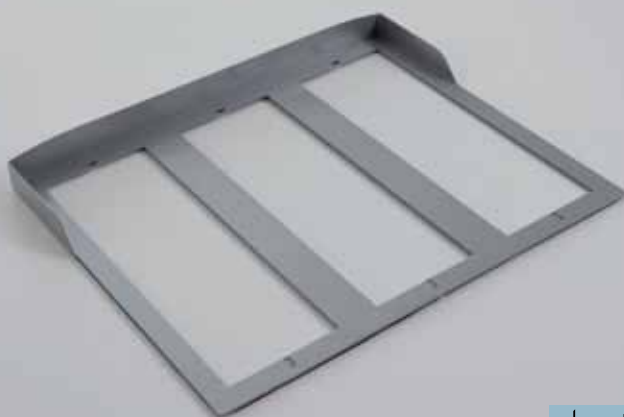

INSTALLING MTM? QUICK AND EASY

There are **5 components** that make up the entry panel: the **recess** or **wall-mounting box**, the **frame**, the **electronic module**, the **frontpiece** with **outer frame**.

No additional buttons or caps.
Maximum flexibility is achieved through the **frontpieces**.

• • • • **RECESS-MOUNTING BOX**
Available for the various entry panel versions, from 1 to 4 modules, depth 48 mm.

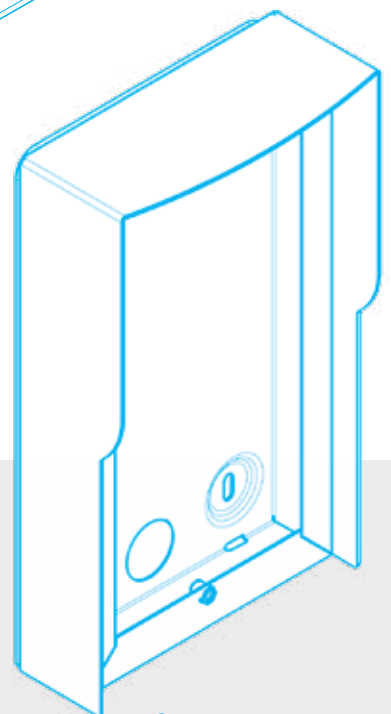
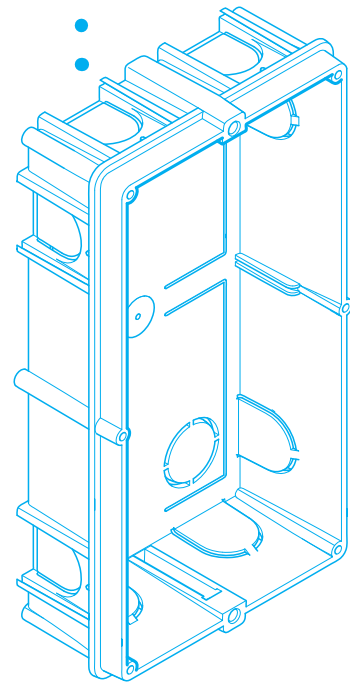

• • • • **WALL-MOUNTING BOX**

A wall-mounting box is available when recess-mounting is not possible.



ELECTRONIC MODULES

Snap-in installation with no screw needed. Simple wiring among the modules. No chance of error thanks to the polarized connectors.

OUTER FRAME

The closing frame is sleek and essential, entirely made of satin-finished aluminum.

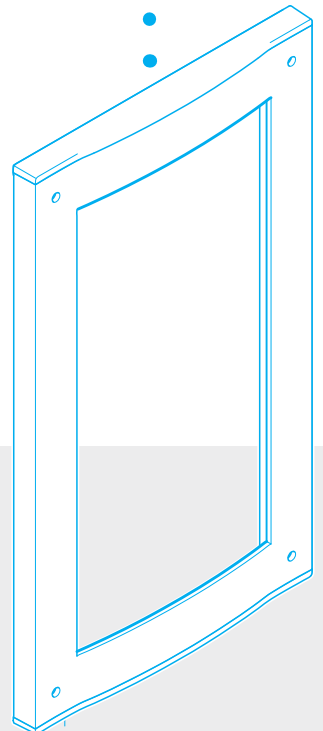
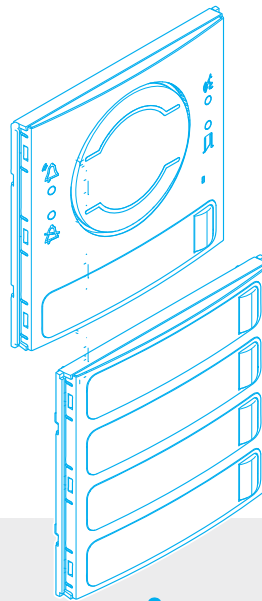
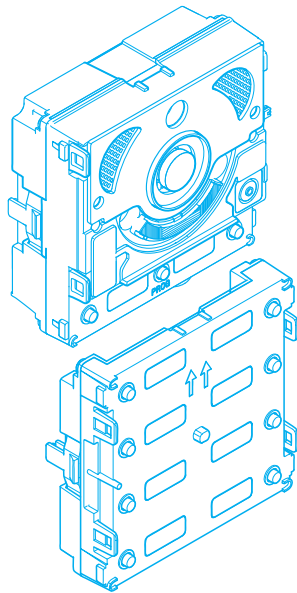
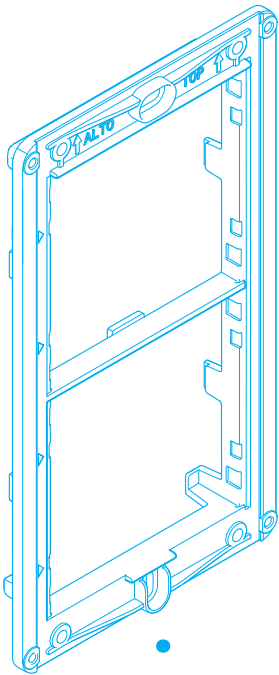

FRAME

Aluminum module-housing profile with cathaphoresis treatment and black paint coat to ensure high levels of endurance against corrosion and rust. Compatible with BTicino and Comelit recess-mounting boxes.

FRONT PIECES

Ready-to-use frontpieces, in that they are already configured and need no extra buttons or caps. Outer side made of satin-finish aluminum and solid sturdy inner structure to achieve an IK07 rating for the entry panel.

VERSATILE: CHOOSE THE SYSTEM BEST SUITED TO YOU

There are **5 available systems**: choose the most **suited to your needs**.

This makes our modular range highly **versatile**, suited for both **small residential systems** as well as **complex video entry installations**.

Especially suited for **restored** buildings where system rewiring is not required.

The logo consists of a stylized 'X' symbol followed by the number '1' inside a square box.The logo features the letters 'XiP' in a bold, sans-serif font, with the 'i' having a dot.The logo displays 'IP360' in a bold, sans-serif font.The logo shows 'GSM' in a large, bold, sans-serif font, with the word 'SYSTEM' in a smaller font to its right.The logo features the text 'MULTI FILARE' above the number '200', which is underlined by three horizontal lines.

FROM THE TOWNHOUSE TO THE APARTMENT BLOCK.

X1 is a system that can be expanded to up to **98 receivers**. It can meet any installation requirements. The system can be integrated with **auxiliary video cameras, access control, remote actuators** and more.

FROM SINGLE HOMES TO LARGE RESIDENTIAL COMPOUNDS.

XIP is a mixed system that used the **IP digital network** as a main structure for communicating among video entry blocks, while maintaining the traditional **analog connecting** towards entry panels and receivers. This choice makes for easy installation of the equipment and significantly augments the system's expansion potential. The system can integrate both the **access-control** and **door-answering modes** to complete the **XIP's** main functions.

FOR THE MOST MODERN RESIDENTIAL, BUSINESS, INDUSTRIAL AND SERVICE SETTINGS.

All the devices of the **IP360** system can be directly **connected to preexisting LANs** to add video entry functions with no need for specific wiring. The **IP360** uses the **Ethernet distribution** as its main communication structure and thanks to this it ensures essentially limitless extension capabilities to the system.

FOR THE MORE ISOLATED ENTRANCES WHEN WIRING IS AN ISSUE.

The **GSM** system is designed to be used on systems where it is not possible to install a traditional video entry system. It works over the **mobile telephone line** and is especially suited when the **distance between entrance and building is significant** or when the entry panel must be connected to a land line or a mobile line.

FOR SMALL APARTMENT BLOCKS.

The **multi-wire system** is designed for residential systems and small apartment blocks. The simple **association between wire and function** with the need to program the system. This makes it very simple to use and reliable over time.

MANY FUNCTIONS, INFINITE SOLUTIONS

AUDIO



Version X1



X1 Lite version



200 version



XIP version



IP version



GSM version

AUDIO / VIDEO



Version X1



XIP version



IP version

BUTTONS



Version X1,
XIP and IP360

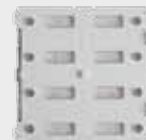

200 version

HEARING IMPAIRED AND VOICE SYNTHESIS



Entering the **MTM** world means being able to choose between **17 modules**. There is a wide variety of functions to make **your entry panel unique**.

The **audio, video modules and buttons** stand out according to their operating system, while the others are suited for all our systems.

KEYPAD



DISPLAY



RFID



KEYPAD FOR ACCESS CONTROL



INFORMATION MODULE



BLIND MODULE



TECHNOLOGICAL CORE, MANY ADVANTAGES!

Many advantages in few centimeters. The **MTM** range includes great features, all standard and on all **audio** and **video** models.

HIGHLY INTEGRATABLE

Besides the normal **discharge output** for the electric lock, there is also a **relay output** featured on the entry panel's terminal board. This can connect to any operator. Also, there are **two programmable**, input-or-output function **terminal boards**. The former is for any additional call buttons or feedback on the state of the door. The latter is for triggering additional auxiliary relays or to notify the state of the door to other systems.



WIDE-ANGLE VISION

The MTM video modules, enhanced by the new wide-eye lens, let you see a very extensive area: **100° horizontal and 82° vertical** openings of the video camera lens.

The **IP360 version** has been further upgraded to a **130° horizontal and 95° vertical** angles, with no image distortion whatsoever.

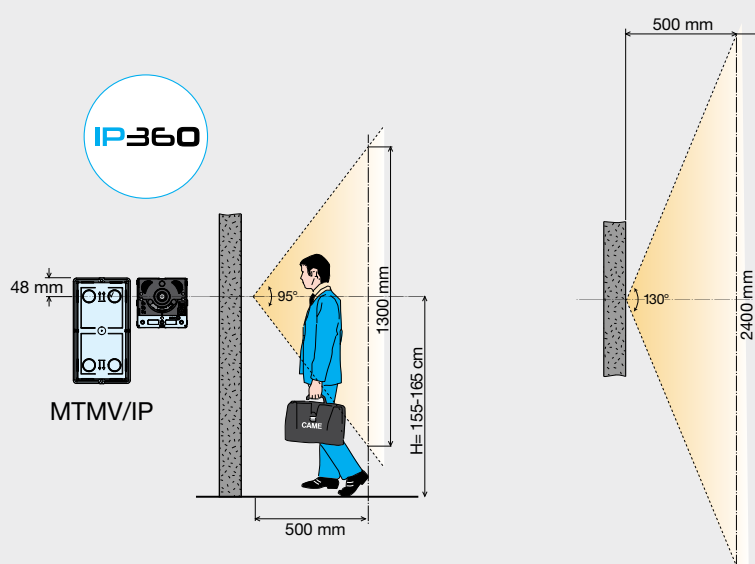

POWER SUPPLY DIRECT IN THE X1 SYSTEM

The entry panel (excluding Audio Lite) **can power the X1** without needing any line VA/01 power-supply units. This makes the structure even simpler.

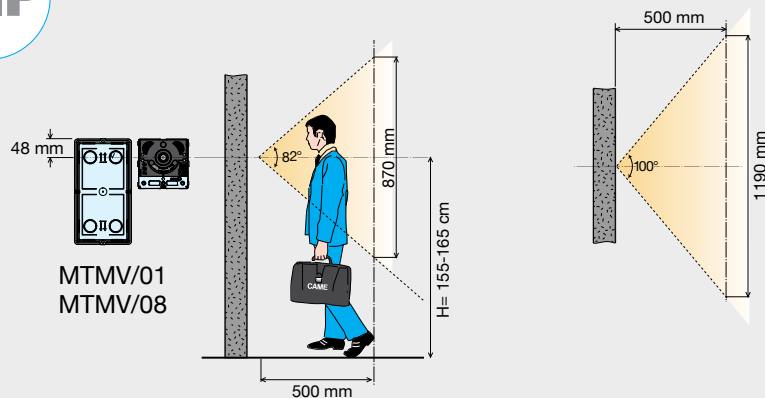
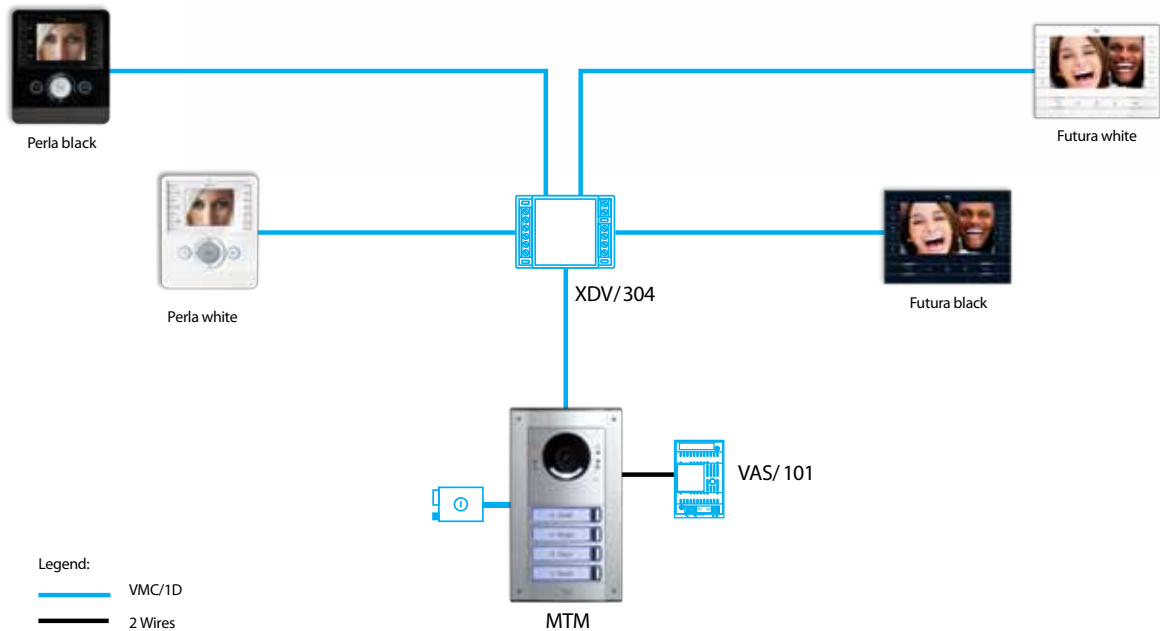

NEW NAME TAG

The MTM range gives you all of the space you need to write the names of all of your family members.

The single-button version is 66 mm in length and 15 mm in length.



CAREFULLY DESIGNED BEAMER

The study conducted on the beamer has led us to achieving perfect illumination. The beamer ensures that the light's angle of diffusion is just right and uniform when lighting up a subject. In this way the intensity provided by the 4 LEDs is best used, without the irritating blinding effect.



SEPARATED VIDEO CAMERA

When installation conditions force you to separate the video camera from the plaque, MTM lets you directly connect a video camera to the module Audio without additional accessories.



TWO-COLOR BACK-LIGHTING

MTM offers a wide choice when it comes to backlighting. The dimmer lets you adjust brightness among the 25%, 50%, 75% & 100% settings. This is true for both blue and white backlighting.



WATER AND IMPACT-PROOF

The MTM entry panels are designed to last. They can count on considerable durability thanks to the **IK07 shock resistance rating** and the **IP54 water and dust proof rating**.

GUARANTEED **IP54** AND **IK07**



EXCELLENT AUDIO QUALITY WHILE MAINTAINING A UNIQUE DESIGN

By carefully choosing our materials and shapes we achieved excellent sound quality without using unattractive holes on the plaque frontpieces.

The audio comes via the video camera lens which diffuses around its edges. This entirely surrounds the user.



ACOUSTIC AND VISUAL ALERTS

We thought of everything when we designed MTM. The visual and acoustic state alerts make our entry panels user-friendly for the elderly and physically challenged.



HD RESOLUTION AND HDR TECHNOLOGY (VERSION IP360)

With its HD 720p resolution and use of HDR (High Dynamic Range) technology, the image quality is greatly enhanced. This yields better dark/light effects even when the image on the screen is highly contrasted.



MANY SPECIAL FUNCTIONS

The difference is in the details and with **MTM** we have thought of everything. From the simplified **audio version** to **GSM**, from access-control extensions to **extreme temperature** accessories, including the **voice synthesis** module.



AUDIO LITE

The perfect solution when you need a simple plaque while maintaining excellent audio quality.

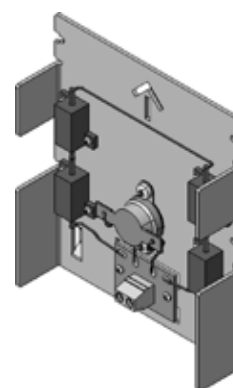

EXTREME TEMPERATURES

When extreme temperatures can cause problems to the system, this accessory warms up the entry panel so it can operate at -40° C.

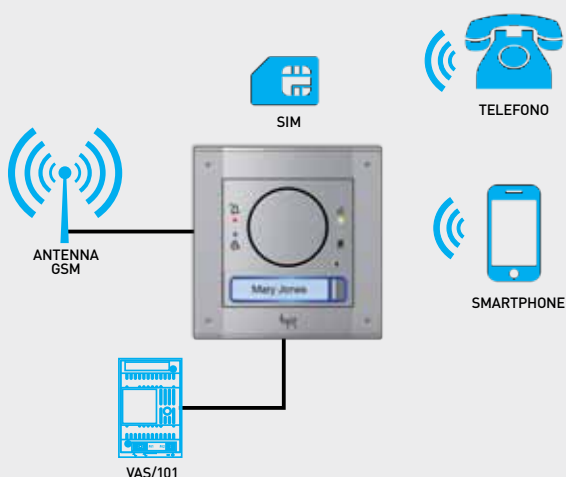

GSM AUDIO

The GSM entry panel is the ideal solution when wiring or distance is an issue, or when you cannot connect up to a receiver. Entry panels are installed in "**stand-alone**" mode, that is, by connecting them to a power-supply unit and to the antenna for receiving the GSM signal.

The plaque is entirely programmed via SMS text messages. Once you have fitted the SIM card, the system is fully operational and the whole video entry system is managed over the smartphone via SMSs and calls.

By pressing the call button, the plaque triggers a call to either mobiles or land lines from which users reply and by using key-combinations can open the front door or gate or barrier.

ACCESS-CONTROL FUNCTIONS

The MTM range also features two **access-control-specific** functional modes (MTMNA - MTMRFID).

These modules can be used by **connecting them to the XIP - IP360 video entry system** as well as in **stand-alone mode**, in which case they autonomously and directly manage the entrance.

Both modules feature **two on-board relay switches - one power and one signal**, for opening doors and other entrances, and, **two inputs** for directly triggering the relay switches.

Up to **3,500** number-codes



MTMNA module + front piece MTMFNA

ACCESS-CONTROL KEYPAD

Up to **6,500** proximity dingles



MTMRFID module + front piece MTMRFID

RFID READER WITH MIFARE TECHNOLOGY

VOICE SYNTHESIS AND THE HEARING IMPAIRED



This module enables hearing-impaired persons wearing T-type magnetic interface hearing aids, to hear the video entry conversations.

It also enables visually-impaired persons to hear a voice synthesis of the triggered commands when interacting with the plaque.

PUSH-BUTTON VERSION?

8, 4, 3, 2....

Just one module, with many faces. You can add a **front-piece** to the module, with the required amount of buttons. So you can set aside any plugs and buttons while keeping your composition options open.



Two-button front-piece



Three-button front-piece



Four-button front-piece



Eight-button front-piece



DIGITAL VERSION?

The **display** lets you view up to **7,200 names in the address book**. When programming, you can choose the search mode that is best for a certain number of users: a simple **scroll list** or an **alphabetic block search** when you have large numbers of users.

The **keypad** lets you activate the video entry and access control functions:

- **digital calls via number codes** (can manage up to 50,000 codes for IP360 systems, and up to 5,000 codes for X1 and XIP systems).
- **control code** to open entrance points (the maximum limit of codes depends on the type of access-control system being used).



DISPLAY module **MTMDY** + frontpiece **MTMFDY**



DISPLAY module **MTMDY** + front piece **MTMFDY**
KEYPAD module **MTMKB** + frontpiece **MTMFKB**



MTM VR VERSION



• • •
FRAME
AND FRONT-
PIECES WHOLLY
MADE OF
ZAMAK, ALL IN
JUST 16 mm

HIGHLY
WEATHER-
AGENT PROOF



SECURITY SCREWS



MTM VANDAL- RESISTANT VERSION FOR GREATER SECURITY AND PEACE-OF-MIND.

All of the functions on the standard version will be available in a new body: **same mechanics and functional modules**, same accessories, but with a vandal-resistant skin.

New design, **with Zamak trimmings**, all VR items can resist up to **IK09** level shocks. This means the MTM series is the most complete range of modular entry panels on the market.

WATER AND SHOCK
PROTECTED



SAME AUDIO AND VIDEO
QUALITY AS THE MTM
VERSION

CRUSH-PROOF
BUTTONS WITH TWO-COLOR
BACKLIGHTING

CUSTOMIZED THIRD-PARTY VANDAL-PROOF PLAQUES



CUSTOMIZE YOUR VANDAL-PROOF ENTRY PANEL

All MTM-range functional modules can be mounted behind **flat customized plaques**, by simply adding a plastic adapter to ensure IP54 level protection and vandalism protection. You can also use **customized buttons** via special expansion-electronics.

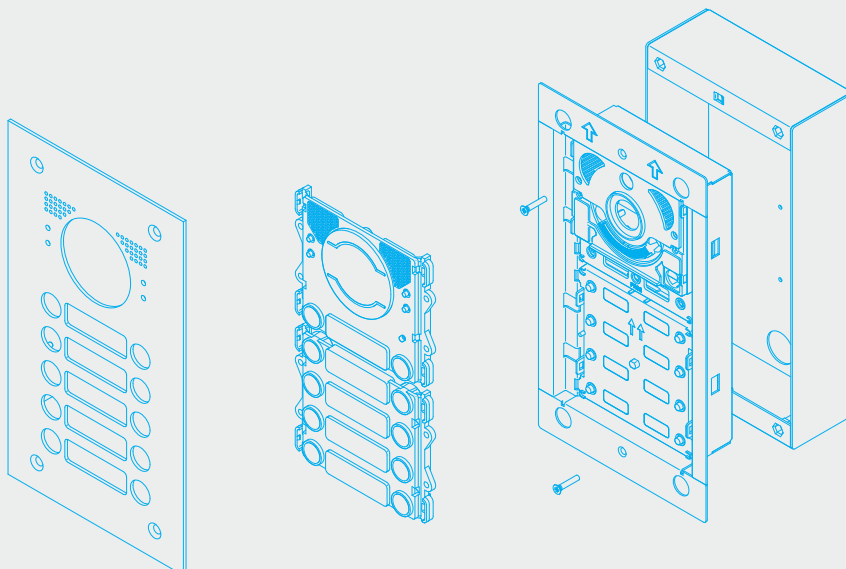

MOUNTING AND INSTALLING

Fitting the **MTM** is **quick** and **easy**.

A few steps is all it takes to assemble and fasten the plaque to the wall. Below you can see the steps needed to fit a two-module video entry panel.

- 1 Wire the terminal board to the wall.
- 2 Fasten the video module to the frame.
- 3 Fasten and connect the second module by using the flat cable.
- 4 Connect the terminal board to the main module.
- 5 Fasten the frame to the recess-mounting box.
- 6 Program and adjust settings on entry panel.
- 7 Add the front pieces.
- 8 Close with the frame.



JUST ONE TERMINAL BOARD FOR CONNECTING TO THE SYSTEM

The system connects to the entry panel via a single terminal board that is connected to the audio or audio/video module. From here, all of the other modules are connected via a single flat anti-inverting cable. It's difficult to get it wrong.



BENCH-ASSEMBLING THE ENTRY PANEL

The plaque is bench-assembled beforehand. The entire module-programming-and-settings phase can be done from the installed entry panel before fitting the front pieces.



MANUAL SETTINGS AND ADJUSTMENTS

Simpler systems can be programmed via the buttons on the audio or audio/video module.

You can, in fact:

- program calls;
- adjust the field of view;
- choose between blue or white backlighting;
- adjust button brightness.



PROGRAMMING VIA USB

Whereas complex systems can use a PC to program the entry panel. By fitting a USB drive into the audio or audio/video module, you can activate the advanced functions or program more complex systems. All programming is done via PCS/XIP software.



CAME CONNECT WE CONNECT. YOU CONTROL.

Today smartphones and tablets have become part of our lives.

These devices have become irreplaceable aids in our lives; also thanks to the Apps that provide control over new functions, every day.

Touching, seeing, hearing have no more limits.

It's all within reach.

To meet these needs **CAME** has developed a series of custom Apps for controlling all of our products.

Enter the **CAME CONNECT** world.



XIP MOBILE

THE APP FOR HAVING YOUR VIDEO ENTRY PANEL ON YOUR SMARTPHONE

The **XIP MOBILE** App lets you manage calls from your audio/video entry system, directly on your smartphone or tablet.

Do you want to see who is ringing the doorbell, even when you're not home?

XIP MOBILE lets you get calls and remotely scan the entry panel area on you mobile device.

There's no need for any additional devices or special configurations. Just connect the system to your home's router.

Answering, checking the video cams' live images and opening the front door, from your smartphone, is now possible.



STANDARD INSTALLATION



THE BEST-SELLING COMPOSITIONS

RECESS-MOUNTING 4-MODULE PROFILE AND FRAME



VIDEO MODULE WITH FRONTPIECE WITH ONE BUTTON TO CALL DOORMAN



DISPLAY FOR BROWSING THE ADDRESS BOOK



DIGITAL KEYPAD FOR CALLING THE REQUIRED UNIT.



RFID FOR OPENING BY USING A BADGE CARD





VIDEO MODULE WITH 2 BUTTONS



TWO 8-CALL MODULES FOR A TOTAL OF 16 BUTTONS



RECESS-MOUNTING 3-MODULE PROFILE AND FRAME



BOX FOR WALL-MOUNTING TWO MODULES WITH RAIN HOOD



VIDEO MODULE WITH 1-BUTTON FRONT PIECE



CALLS MODULE WITH 4-BUTTON FRONTPIECE



BEST SELLING VR COMPOSITIONS





VANDAL-PROOF 3-MODULE
RECESS-MOUNTING
PROFILE AND FRAME

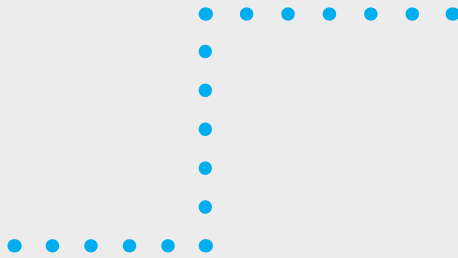

TWO 8-CALL MODULES
FOR A TOTAL OF 8
BUTTONS



VANDAL-PROOF 2-MODULE
WALL-MOUNTING BOX WITH
RAIN HOOD.

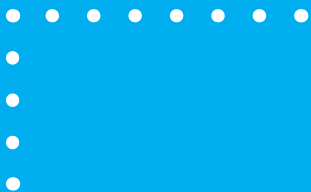

AUDIO MODULE WITH
VANDAL-PROOF
FRONTPIECE WITHOUT
CALL BUTTONS



EXAMPLE SYSTEMS

RESIDENTIAL

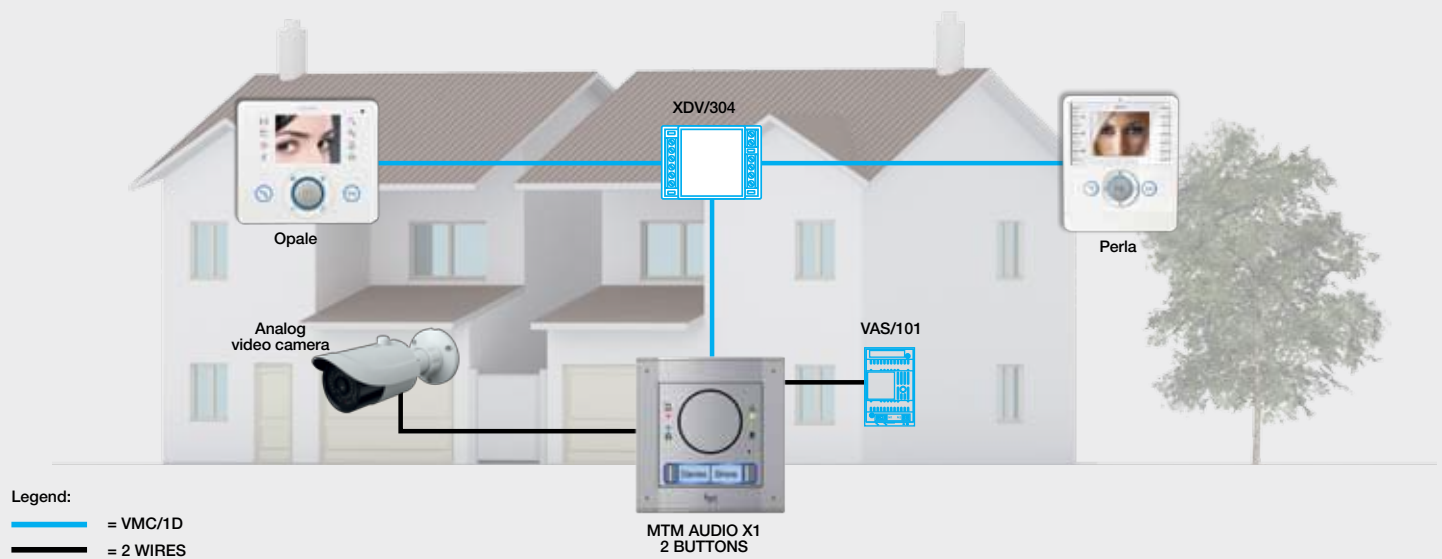

TWO-FAMILY RESIDENTIAL UNIT

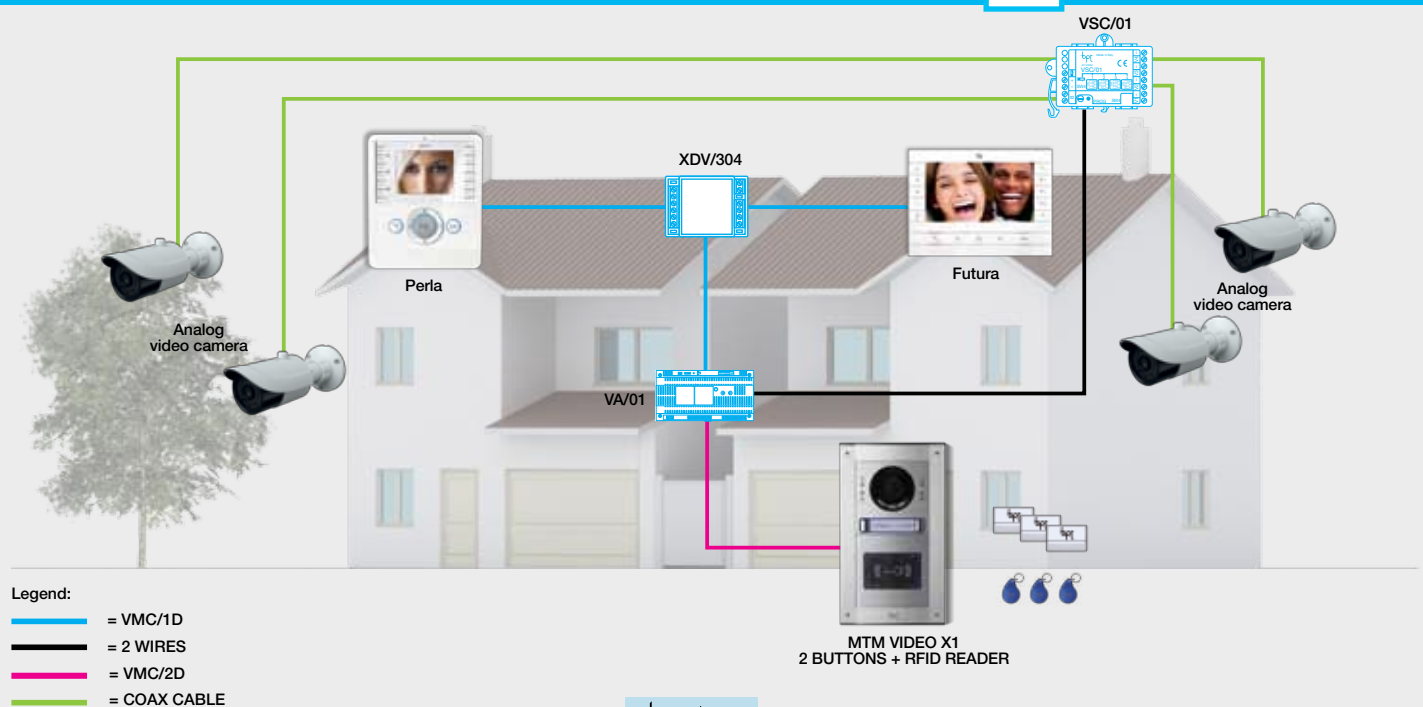

MTM provides for maximum flexibility. You can set up small residential systems, with audio only or audio/video systems. Choose among the various systems that we make available. Below you will find some installation examples that show the potential of the range and sheer simplicity with which it lets you manage any request.

SERVERLESS RESIDENTIAL

IP-360

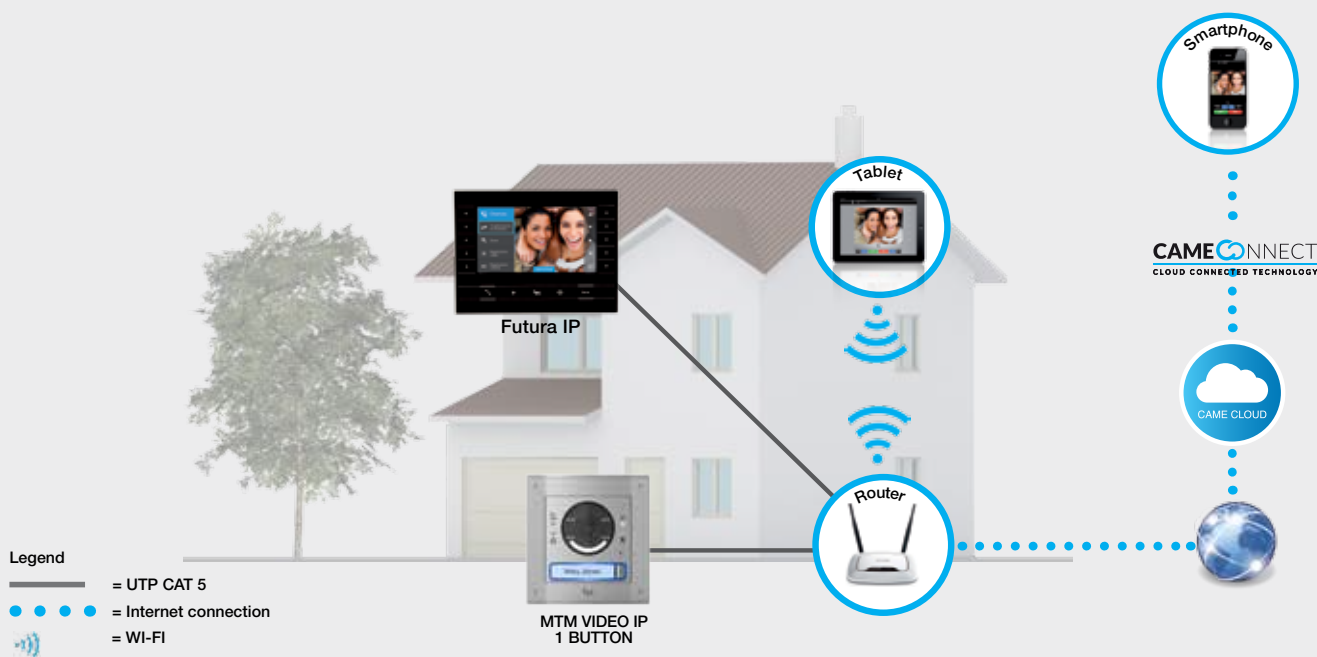

SERVERLESS RESIDENTIAL BUILDING

IP-360

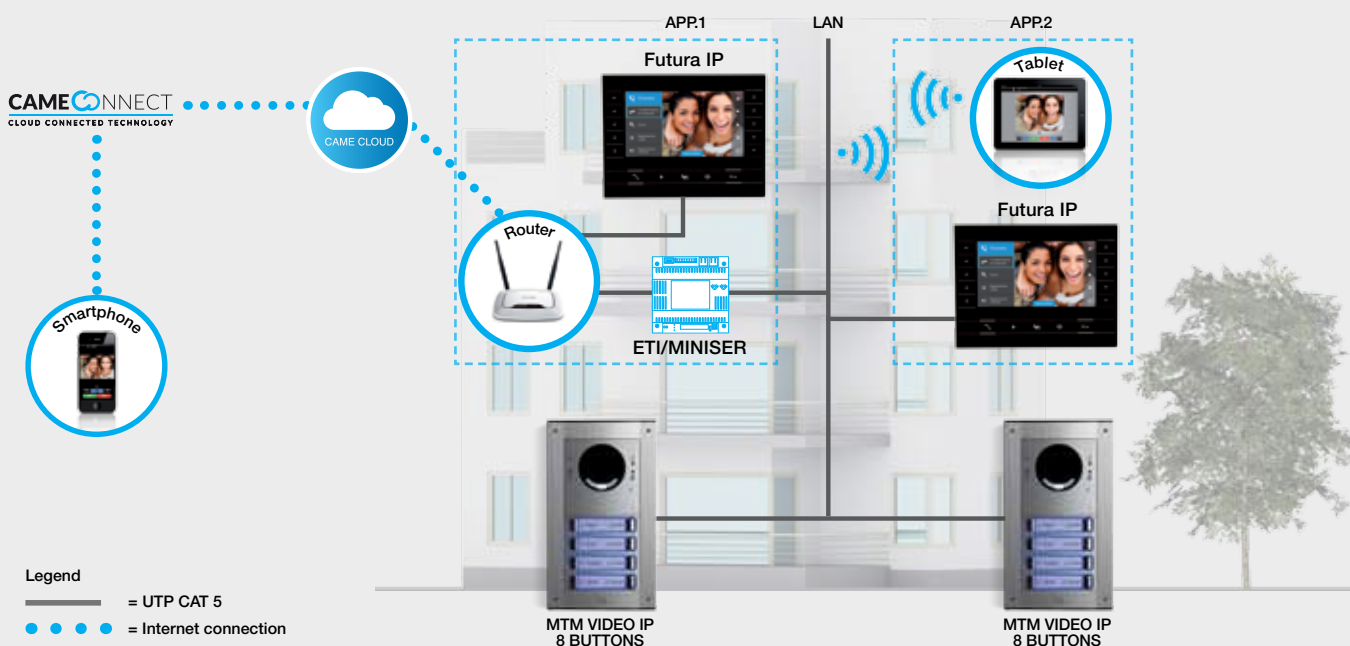

EXAMPLE SYSTEMS

URBAN

IP-360

COMPOUND 1

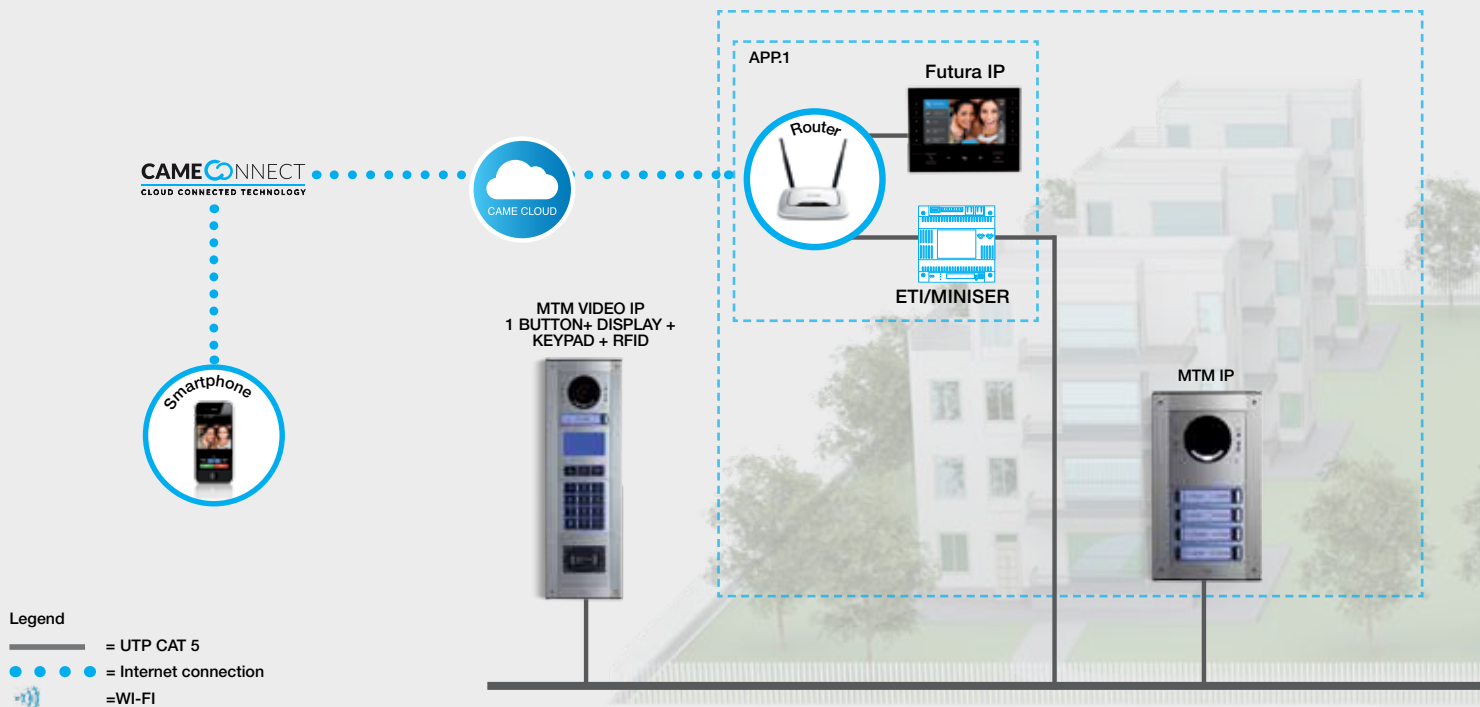

URBAN

XiP



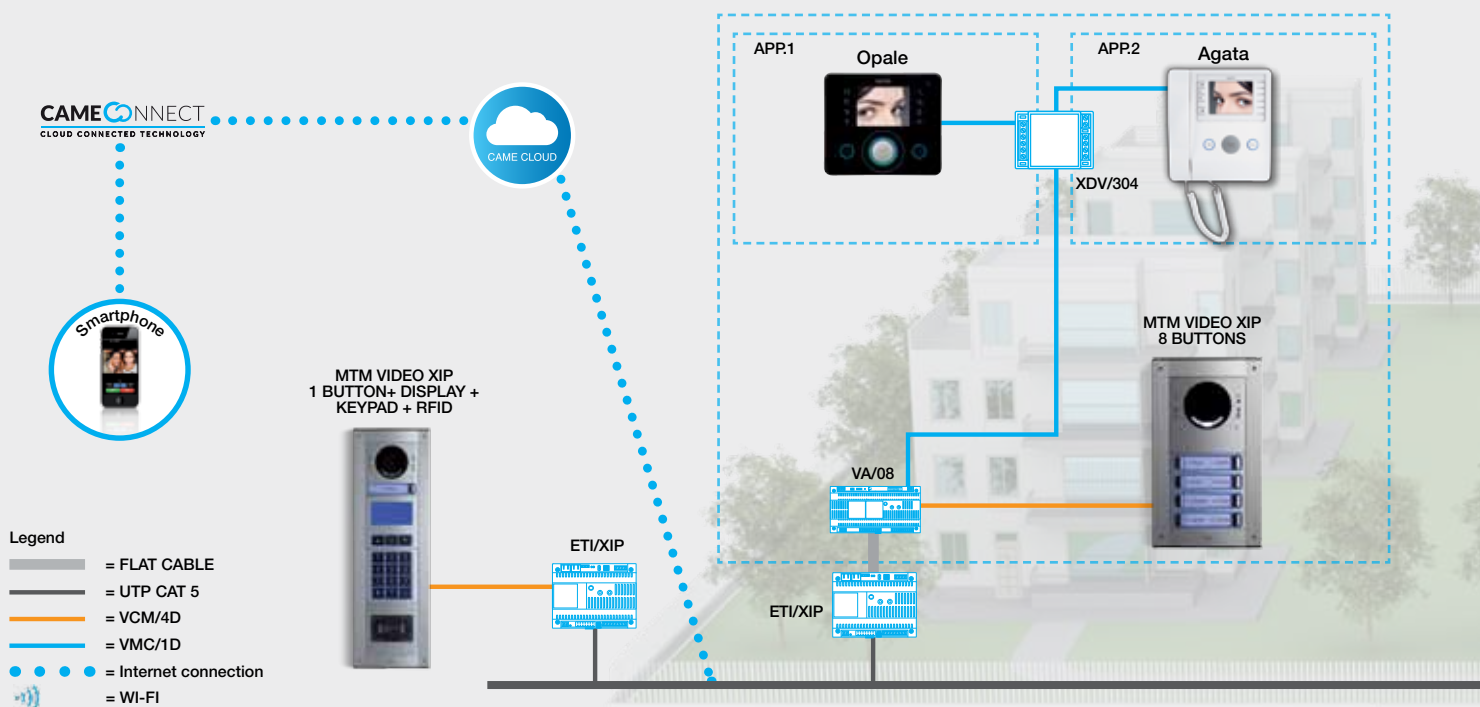



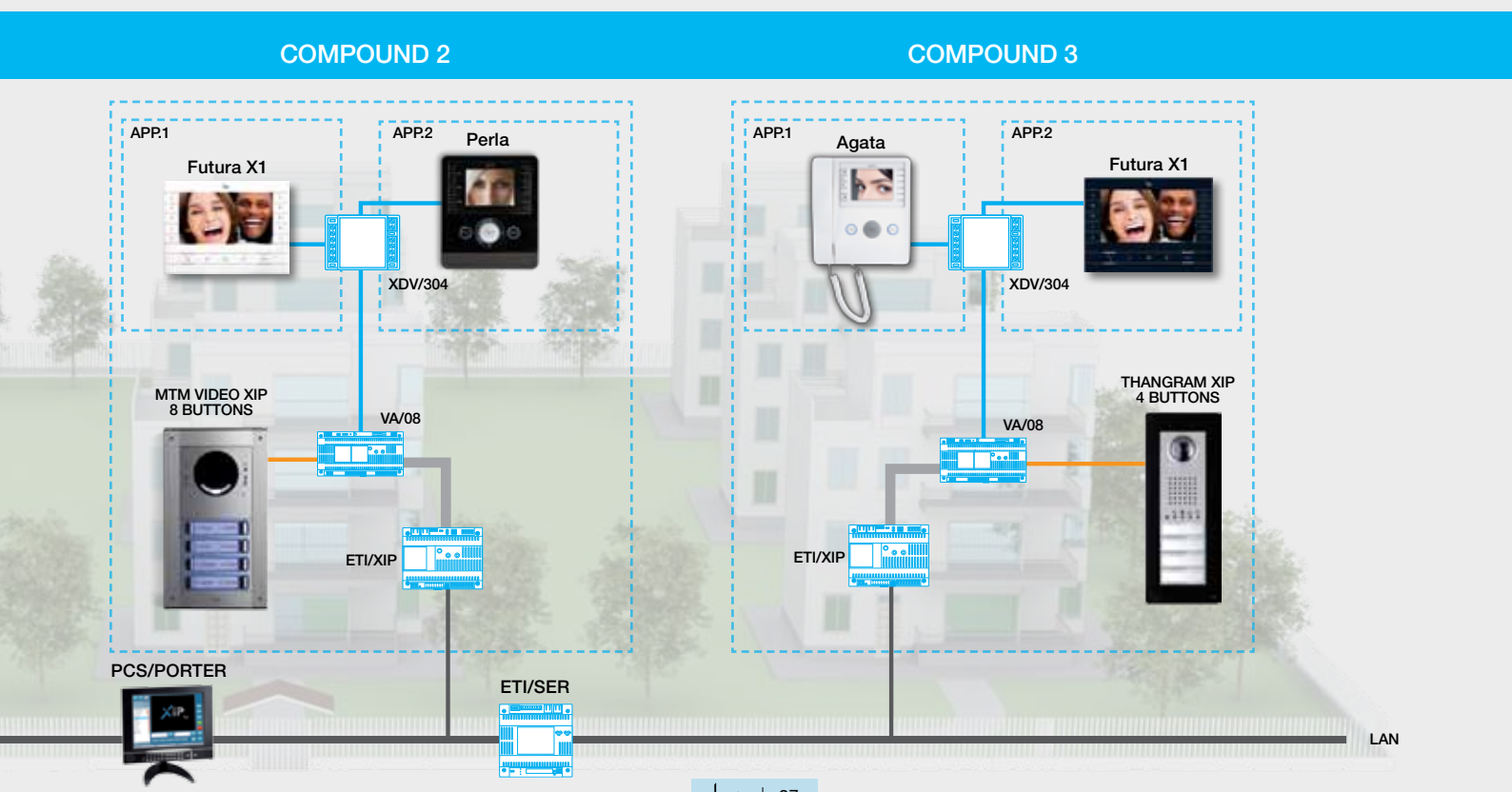
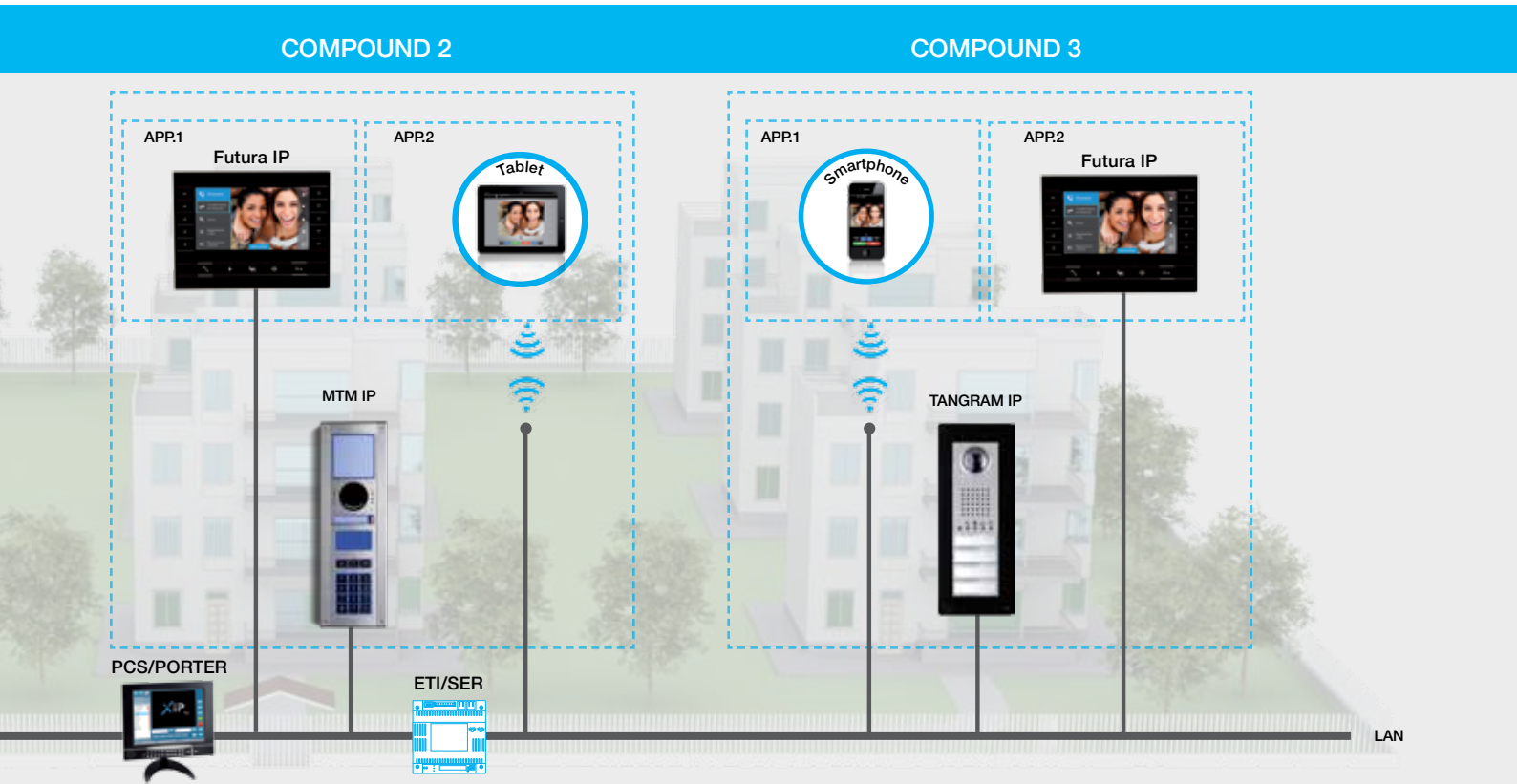

COMPOUND 1















MTM lets you set up large system and manage residential compounds with countless apartment blocks using either the IP360 system or the XIP system.



COMPOSITION TABLE

number of calls	VIDEO MODULE	POWER-SUPPLY UNIT	KEYPAD MODULE	DISPLAY MODULE	FRONT PIECES				
									
	MTMV/01 One Video module	VAS/100.30 Power-supply unit 230 V	MTMKB Digital-call keypad module	MTMDY Display module	MTMFV0P Blank video front-piece	MTMFV1P One-button video front-piece	MTMFV2P Two-button video front-piece	MTMFKB Keypad module front-piece	MTMFDY Display module front-piece
	62030010	62703310	60020230	60020240	62030030	62030040	62030050	60020270	60020280
up to 98	1	1	1	1	1	0	0	1	1
98 +P**	1	1	1	1	0	1	0	1	1

*For every ten XDV/304s, add an XDV/300A; after 64 receivers, add an XAS/301.01
 ** P = porter

number of calls	VIDEO MODULE	POWER-SUPPLY UNIT	CALLS MODULE	FRONT PIECES			BUTTONS				RECESS-MOUNTED	
												
	MTMV/01 One video module	VAS/100.30 Power-supply unit 230 V	MTM8C Eight-button module	MTMFV0P Blank video front-piece	MTMFV1P One-button video front-piece	MTMFV2P Two-button video front-piece	MTMF2P Two-button front-piece	MTMF3P Three-button front-piece	MTMF4P Four-button front-piece	MTMF8P Eight-button front-piece	MTMSI1M One-module recess-mounting box	MTMSI2M Two-module recess-mounting box
	62030010	62703310	60020030	62030030	62030040	62030050	60020110	60020120	60020130	60020140	60020150	60020160
1	1	1	0	0	1	0	0	0	0	0	1	0
2	1	1	0	0	0	1	0	0	0	0	1	0
3	1	1	1	1	0	0	0	1	0	0	0	1
4	1	1	1	1	0	0	0	0	1	0	0	1
5	1	1	1	0	1	0	0	0	1	0	0	1
6	1	1	1	1	0	0	0	0	0	1	0	1
7	1	1	1	1	0	0	0	0	0	1	0	1
8	1	1	1	1	0	0	0	0	0	1	0	1
9	1	1	1	0	0	1	0	0	0	1	0	1
10	1	1	1	0	0	1	0	0	0	1	0	1
11	1	1	3	1	0	0	0	1	2	0	0	0
12	1	1	3	1	0	0	0	0	3	0	0	0
13	1	1	3	0	1	0	0	0	3	0	0	0
14	1	1	2	1	0	0	0	0	0	2	0	0
15	1	1	2	1	0	0	0	0	0	2	0	0
16	1	1	2	1	0	0	0	0	0	2	0	0
17	1	1	2	0	0	1	0	0	0	2	0	0
18	1	1	2	0	0	1	0	0	0	2	0	0
19	1	1	5	1	0	0	0	1	4	0	0	0
20	1	1	5	1	0	0	0	0	5	0	0	0
56	1	1	7	1	0	0	0	0	0	7	0	0
90	1	1	11	0	0	1	0	0	0	11	0	0

*For every ten XDV/304s, add an XDV/300A; after 64 receivers, add an XAS/301.01

Receivers

Upgrade your system with one of our monitors.
Choose among, Agata, Perla, Opale and Futura to find the perfect solution to your needs.



RECESS-MOUNTING BOX	FRAME + PLAQUE	ADDITIONAL FUNCTIONS (OPTIONAL)				VIDEO SPLITTER	RECEIVERS
							AS CHOSEN
MTMSI3M Three-module recess-mounting box	MTMTP3M Three-module frame + plaque	MTMRFID MTMFRFID Module + front-piece RFID	MTMNA MTMFNA Access-control module + front-piece	MTMBFVS MTMFBS Hearing-impaired module + front-piece	MTMMI MTMFMI Module + data front-piece	XDV/304 Four-output video splitter	
60020620	60020340	60020250 60020260	60020380 60020910	60020390 60020920	60020290 60020300	62821300	
1	1	For each additional function added to a video entry panel, consider that the recess-mounting box and the frame will need an extra space for an additional module.				up to 25	up to 98
1	1					up to 25	up to 98

BOX		FRAME + PLAQUE				ADDITIONAL FUNCTIONS (OPTIONAL)				VIDEO SPLITTER	RECEIVERS
											AS CHOSEN
MTMSI3M Three-module recess-mounting box	MTMSI4M Four-module recess-mounting box	MTMTP1M One-module frame + plaque	MTMTP2M Two-module frame + plaque	MTMTP3M Three-module frame + plaque	MTMTP4M Four-module frame + plaque	MTMRFID MTMFRFID RFID module + frame	MTMNA MTMFNA Access-control module + front-piece	MTMBFVS MTMFBS Hearing-impaired module + front-piece	MTMMI MTMFMI Module + data front-piece	XDV/304 * Four-output video splitter	
60020620	60020330	60020170	60020180	60020340	60020350	60020250 60020260	60020380 60020910	60020390 60020920	60020290 60020300	62821300	
0	0	1	0	0	0	For each additional function added to a video entry panel, consider that the recess-mounting box and the frame will need an extra space for an additional module.				1	1
0	0	1	0	0	0					1	2
0	0	0	1	0	0					1	3
0	0	0	1	0	0					1	4
0	0	0	1	0	0					2	5
0	0	0	1	0	0					2	6
0	0	0	1	0	0					2	7
0	0	0	1	0	0					2	8
0	0	0	1	0	0					3	9
0	0	0	1	0	0					3	10
0	1	0	0	0	1					3	11
0	1	0	0	0	1					3	12
0	1	0	0	0	1					4	13
1	0	0	0	1	0					4	14
1	0	0	0	1	0					4	15
1	0	0	0	1	0					4	16
1	0	0	0	1	0					5	17
1	0	0	0	1	0					5	18
2	0	0	0	2	0					5	19
2	0	0	0	2	0					5	20
0	2	0	0	0	2					14	56
0	3	0	0	0	3					23	90

CODES

MODULES

MTMA/01 60020010 



AUDIO MODEL FOR THE X1 SYSTEM

MTMAL/01 60020020 



AUDIO LITE MODULE FOR THE X1 SYSTEM

MTMA/200 60020210 



AUDIO MODULE FOR THE 200 SYSTEM

MTMA/IP 60020040 



AUDIO MODEL FOR THE IP360 SYSTEM

MTMA/08 60020420 



AUDIO MODULE FOR THE XIP SYSTEM

MTMA/GSM 60020410 



GSM AUDIO MODULE

MTMV/01 62030010 



AUDIO-VIDEO MODULE FOR THE X1 SYSTEM

MTMV/IP 62030020 



AUDIO-VIDEO MODULE FOR THE IP360 SYSTEM

MTMV/08 62030060 



AUDIO-VIDEO MODULE FOR THE XIP SYSTEM

MTM8C 60020030



8-CALL MODULE

MTM8C/200 60020220 



8-CALL MODULE FOR THE 200 SYSTEM

MTMBFVS 60020390



HEARING IMPAIRED VOICE SYNTHESIS MODULE

MTMKB 60020230



DIGITAL-CALL KEYPAD MODULE

MTMDY 60020240



DISPLAY MODULE

MTMRFID 60020250



RFID ACCESS-CONTROL MODULE

MTMMI 60020290



INFORMATION MODULE

MTMMC 60020310



MODULE + BLIND FRONTPIECE

MTMNA 60020380



ACCESS-CONTROL KEYPAD MODULE

FRONT PIECES

MTMFAOP 60020050



BLIND AUDIO FRONT-PIECE

MTMFA1P 60020060



AUDIO FRONT-PIECE SINGLE BUTTON

MTMFA2P 60020070



AUDIO FRONT-PIECE DOUBLE BUTTON

MTMFALOP 60020080



AUDIO FRONT-PIECE LITE BLIND

CODES

MTMFAL1P 60020090



LITE AUDIO FRONT-PIECE
SINGLE BUTTON

MTMFAL2P 60020100



LITE AUDIO FRONT-PIECE
DOUBLE BUTTON

MTMFV0P 62030030



BLIND VIDEO
FRONT-PIECE

MTMFV1P 62030040



VIDEO FRONT-PIECE
SINGLE BUTTON

MTMFV2P 62030050



VIDEO FRONT-PIECE
DOUBLE BUTTON

MTMF2P 60020110



2-BUTTON FRONT-PIECE

MTMF3P 60020120



3-BUTTON FRONT-PIECE

MTMF4P 60020130



4-BUTTON FRONT-PIECE

MTMF8P 60020140



8-BUTTON FRONT-PIECE

MTMFRFID 60020260



MODULE FRONT-PIECE
RFID

MTMFKB 60020270



KEYPAD MODULE
FRONT-PIECE

MTMFDY 60020280



MODULE FRONT-PIECE
DISPLAY

MTMFM1 60020300



INFORMATION MODULE
FRONT-PIECE

MTMFMNA 60020910



FRONT-COVER FOR
ACCESS-CONTROL KEYPAD

MTMFBF 60020920



HEARING IMPAIRED
AND VOICE SYNTHESIS
MODULE FRONT-PIECE

MTMTP1M 60020170



FRAME+PLAQUE 1M

MTMTP2M 60020180



FRAME+PLAQUE 2M

MTMTP3M 60020340



FRAME+PLAQUE 3M

MTMTP4M 60020350



FRAME+PLAQUE 4M

MTMS1M 60020150



1M RECESS-MOUNTING BOX

MTMS2M 60020160



RECESS-MOUNTING BOX 2M

MTMS3M 60020320



RECESS-MOUNTING
BOX 3M

MTMS4M 60020330



RECESS-MOUNTING BOX 4M

FRONT PIECES

FRAMES

RECESS-MOUNTING
ACCESSORIES

CODES

RECESS-MOUNTING ACCESSORIES

MTMTI1M 60020490

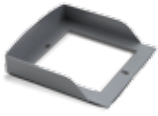

RECESS-MOUNTING
RAIN HOOD 1M

MTMTI2M 60020500

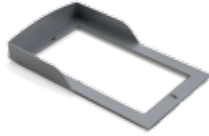

RECESS-MOUNTING
RAIN HOOD 2M

MTMTI3M 60020510



RECESS-MOUNTING
RAIN HOOD 3M

MTMTI4M 60020520



RECESS-MOUNTING
RAIN HOOD 4M

MTMTI1M2 60020530



RECESS-MOUNTING
RAIN HOOD 1Mx2

MTMTI1M3 60020540



RECESS-MOUNTING
RAIN HOOD 1Mx3

MTMTI1M4 60020550



RECESS-MOUNTING
RAIN HOOD 1Mx4

MTMTI2M2 60020560



RECESS-MOUNTING
RAIN HOOD 2Mx2

MTMTI3M2 60020570

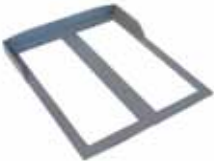

RECESS-MOUNTING
RAIN HOOD 3Mx2

MTMTI3M3 60020580

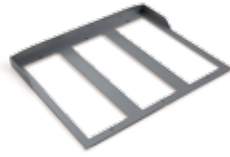

RECESS-MOUNTING
RAIN HOOD 3Mx3

MTMSP1M 60020190



WALL-MOUNTING BOX
WITH RAIN HOOD 1M

MTMSP2M 60020200



WALL-MOUNTING BOX
WITH RAIN HOOD 2M

MTMSP3M 60020360



WALL-MOUNTING BOX
WITH RAIN HOOD 3M

MTMSP4M 60020370



WALL-MOUNTING BOX
WITH RAIN HOOD 4M

MTMSP1M2 60020430

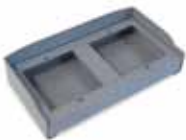

WALL-MOUNTING BOX
WITH RAIN HOOD 1Mx2

MTMSP1M3 60020440



WALL-MOUNTING BOX
WITH RAIN HOOD 1Mx3

MTMSP1M4 60020450



WALL-MOUNTING BOX
WITH RAIN HOOD 1Mx4

MTMSP2M2 60020460



WALL-MOUNTING BOX
WITH RAIN HOOD 2Mx2

MTMSP3M2 60020470



WALL-MOUNTING BOX
WITH RAIN HOOD 3Mx2

MTMSP3M3 60020480



WALL-MOUNTING BOX
WITH RAIN HOOD 3Mx3

WALL-MOUNTING ACCESSORIES

CODES

<p>MTMFA0PVR 60020600</p>  <p>VR BLIND AUDIO FRONTPIECE</p>	<p>MTMFA1PVR 60020610</p>  <p>VR SINGLE-BUTTON AUDIO FRONTPIECE</p>	<p>MTMFA2PVR 60020620</p>  <p>VR DOUBLE-BUTTON AUDIO FRONTPIECE</p>	<p>MTMFA0PVR 60020630</p>  <p>VR LITE BLIND AUDIO FRONTPIECE</p>
<p>MTMFAL1PVR 60020640</p>  <p>LITE AUDIO FRONT-PIECE VR SINGLE BUTTON</p>	<p>MTMFAL2PVR 60020650</p>  <p>LITE AUDIO FRONT-PIECE VR DOUBLE BUTTON</p>	<p>MTMFOVR 62030070</p>  <p>VIDEO FRONT-PIECE VR BLIND</p>	<p>MTMFOVR 62030080</p>  <p>AUDIO-VIDEO FRONTPIECE VR SINGLE BUTTON</p>
<p>MTMFV2PVR 62030090</p>  <p>VR DOUBLE-BUTTON AUDIO-VIDEO FRONTPIECE</p>	<p>MTMMCVR 60020730</p>  <p>MODULE + FRONTPIECE BLIND VR</p>	<p>MTMF2PVR 60020660</p>  <p>2-BUTTON FRONT-PIECE VR</p>	<p>MTMF3PVR 60020670</p>  <p>3-BUTTON FRONT-PIECE VR</p>
<p>MTMF4PVR 60020680</p>  <p>VR 4-BUTTON FRONTPIECE</p>	<p>MTMF8PVR 60020690</p>  <p>VR FRONTPIECE 8-BUTTON</p>	<p>MTMFKBVR 60020700</p>  <p>VR KEYPAD MODULE FRONTPIECE</p>	<p>MTMFDYVR 60020710</p>  <p>VR DISPLAY MODULE FRONTPIECE</p>
<p>MTMFRFIDVR 60020720</p>  <p>VR RFID ACCESS- CONTROL MODULE FRONT PIECE</p>	<p>MTMFAVR 60020930</p>  <p>VR KEYPAD ACCESS- CONTROL MODULE FRONTPIECE</p>	<p>MTMGT 60020400</p>  <p>HEATER ACCESSORY</p>	
<p>MTMTP1MVR 60020740</p>  <p>PROFILE+PLAQUE 1M VR</p>	<p>MTMTP2MVR 60020750</p>  <p>PROFILE+PLAQUE 2M VR</p>	<p>MTMTP3MVR 60020760</p>  <p>PROFILE+PLAQUE 3M VR</p>	<p>MTMTP4MVR 60020770</p>  <p>PROFILE+PLAQUE 4M VR</p>

MTM VR FRONTPIECES

ACCESSORIES

VR MTM FRAMES

ITALY
CAME S.p.A., Treviso
CAME Italia, Treviso

BELGIUM
CAME Benelux, Lessines

CROATIA
CAME Adriatic, Kastav

FRANCE
CAME France, Paris

GERMANY
CAME Deutschland GmbH, Stuttgart

IRELAND
CAME BPT Ireland, Dublin

NETHERLANDS
CAME Nederland, Breda

POLAND
CAME Poland, Warsaw

PORTUGAL
CAME Portugal, Lisbon

RUSSIA
CAME Rus, Moscow

SPAIN
CAME Spain, Madrid

UK
CAME United Kingdom, Nottingham

BRAZIL
CAME do Brasil Serviços de Automação, São Paulo

CHILE
CAME PARKARE Chile, Santiago

MEXICO
CAME Automatismos de Mexico, Mexico City

PERÚ
CAME PARKARE Perú, Lima

USA
CAME Americas Automation, Miami

INDIA
CAME India Automation Solutions, New Delhi

U.A.E.
CAME Gulf, Dubai

SOUTH AFRICA
CAME BPT South Africa, Johannesburg

CAME
safety&comfort

Came S.p.A.

Via Martiri della Libertà, 15
31030 Dosson di Casier
Treviso - Italy

www.came.com

© CAME SPA - KBCENAD316 - 05/2017 - EN
YOU MAY NOT EVEN PARTIALLY REPRODUCE THIS DOCUMENT
CAME RESERVES THE RIGHT TO MAKE ANY CHANGES
TO THIS DOCUMENT AT ANY TIME